

CS200: Graphs

Prichard Ch. 14

Rosen Ch. 10

Graphs



A collection of nodes and edges

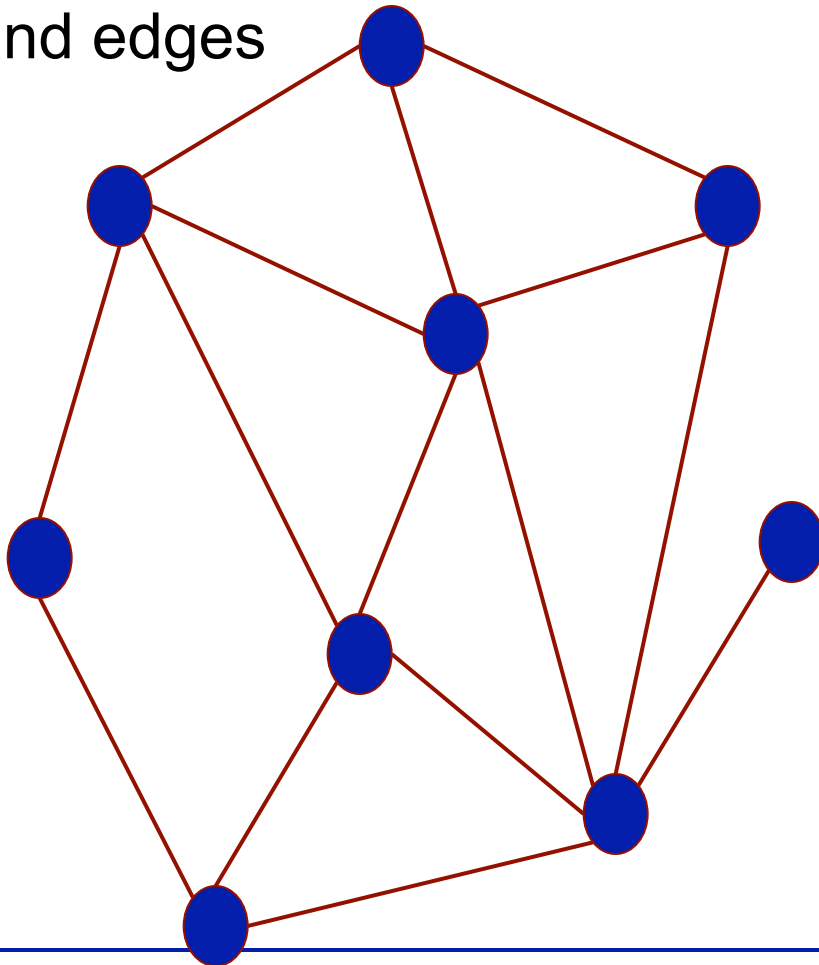

What can this represent?

- A computer network
- Abstraction of a map
- Social network

Directed Graphs

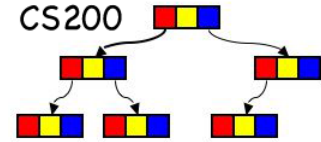

A collection of nodes and directed edges

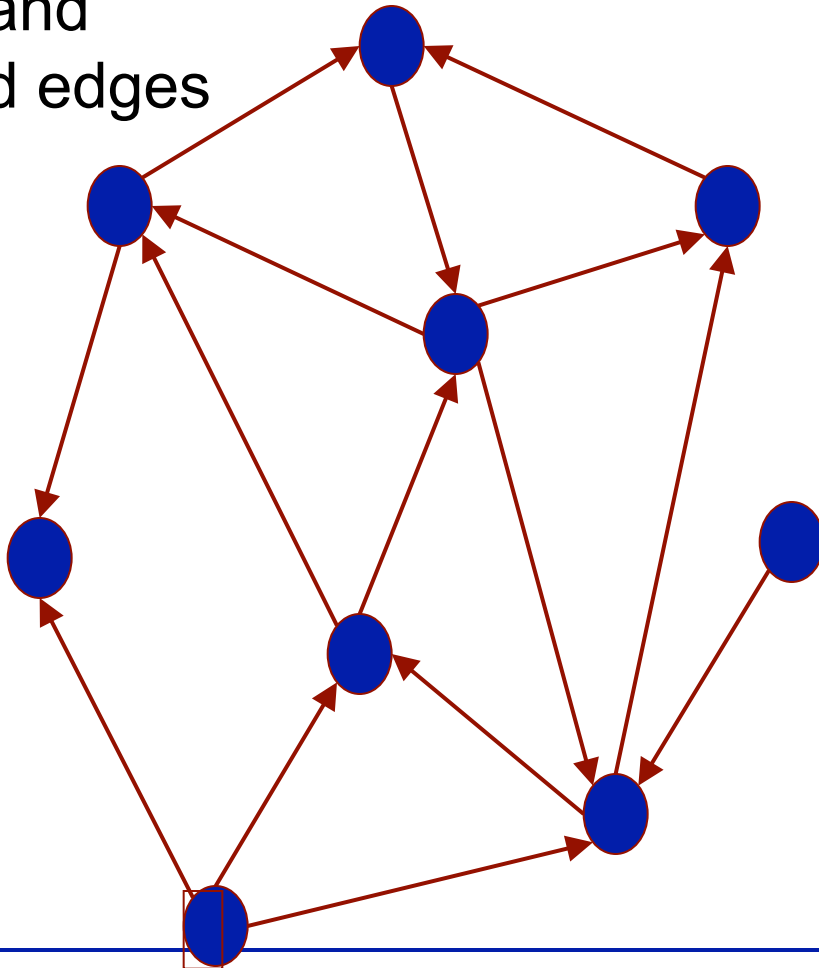

Sometimes we want to represent directionality:

- Unidirectional network connections
- One way streets
- The web

Graphs/Networks Around Us

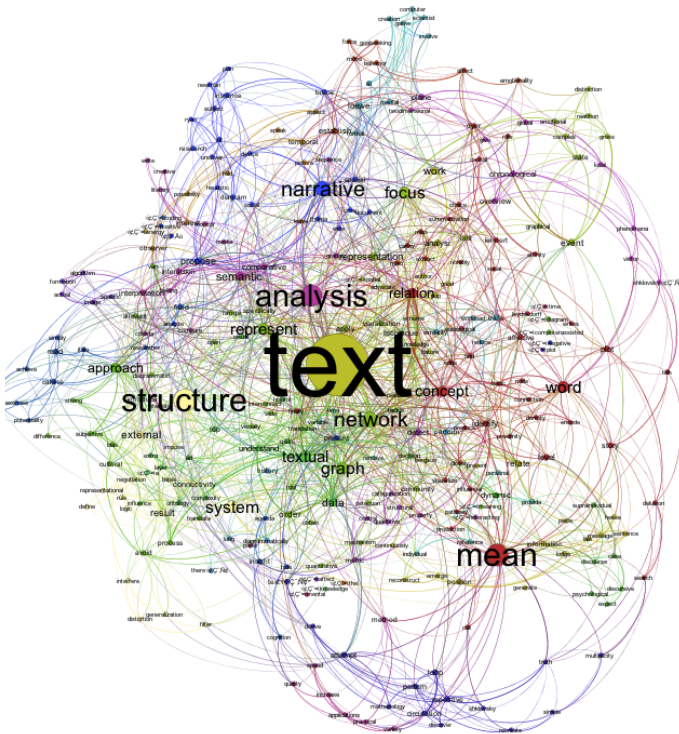
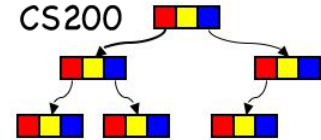

<http://lin-ear-th-inking.blogspot.com/2010/12/visualizing-geodetic-information-with.html>

<http://noduslabs.com/wp-content/uploads/2011/12/figure-5-meaning-circulation.png>

Graph Terminology

$$G=(V, E)$$

Vertices Edges

Edges

Vertices/
Nodes

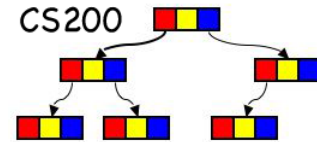
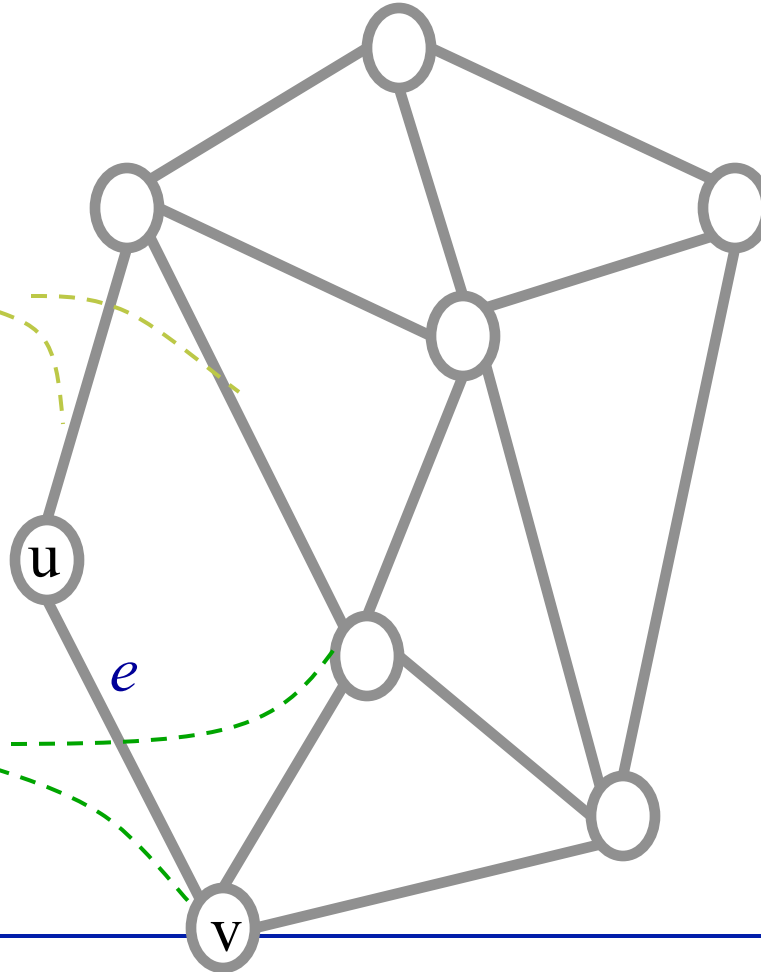

Two vertices (or nodes) are **adjacent** if they are connected by an edge. An edge is **incident** on two vertices, an edge e can be represented by two vertices (u,v)
Degree of a vertex or node: number of edges incident on it

Graph terminology:
14.1 in Prichard,
10.1 in Rosen

Undirected Graphs

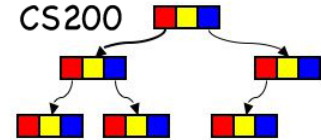

- Undirected graph. $G = (V, E)$
 - V = set of nodes.
 - E = set of edges between pairs of nodes.
 - Captures pairwise relationship between objects.
 - Graph size parameters: $n = |V|$, $m = |E|$.

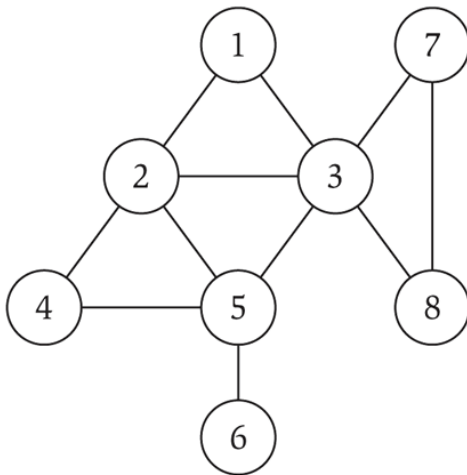

$V = \{ 1, 2, 3, 4, 5, 6, 7, 8 \}$

$E = \{ 1-2, 1-3, 2-3, 2-4, 2-5, 3-5, 3-7, 3-8, 4-5, 5-6 \}$

$n = 8$

$m = 11$

Directed Graphs

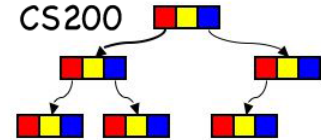

- Directed graph. $G = (V, E)$
 - Edge (u, v) goes from node u to node v .

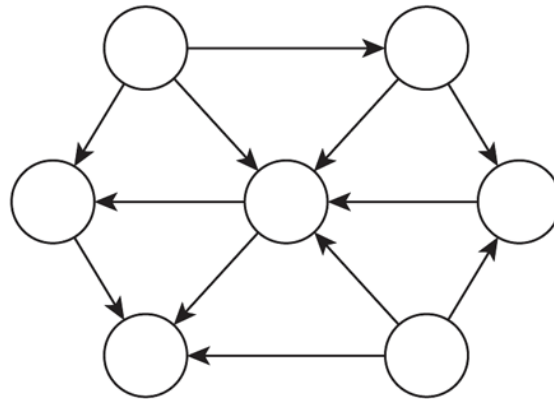

- Example. Web graph - hyperlink points from one web page to another.
 - Modern web search engines exploit hyperlink structure to rank web pages by importance (pageRank).

Graph definitions

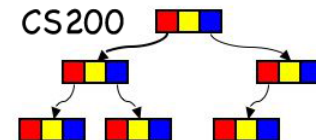

Graph $G = (V, E)$, V : set of **nodes** or vertices,
 E : set of **edges** (pairs of nodes).

In an **undirected** graph, edges are unordered pairs (sets) of nodes. In a **directed** graph edges are ordered pairs (2-tuples) of nodes.

Path: sequence of nodes $(v_0..v_n)$ s.t. $\forall i: (v_i, v_{i+1})$ is an edge. **Path length**: number of edges in the path, or sum of weights. **Simple path**: all nodes distinct.

Cycle: path with first and last node equal. **Acyclic graph**: graph without cycles. **DAG**: directed acyclic graph.

Two nodes are **adjacent** if there is an edge between them. In a **complete graph** all nodes in the graph are adjacent.

More definitions

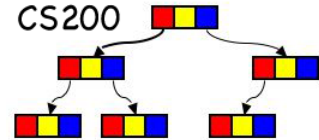

An undirected graph is **connected** if for all nodes v_i and v_j there is a path from v_i to v_j .

$G'(V', E')$ is a **sub-graph** of $G(V, E)$ if $V' \subseteq V$ and $E' \subseteq E$

The sub-graph of G **induced** by V' has all the edges $(u, v) \in E$ such that $u \in V'$ and $v \in V'$.

In a **weighted graph** the edges have a weight (cost, length,...) associated with them.

Graph Terminology



induced
subgraph

A **subgraph** of a graph $G = (V, E)$ is a graph (V', E') such that V' is a subset of V and, E' is a subset of E

The sub-graph of G **induced** by V' has all the edges $(u, v) \in E$ such that $u \in V'$ and $v \in V'$.

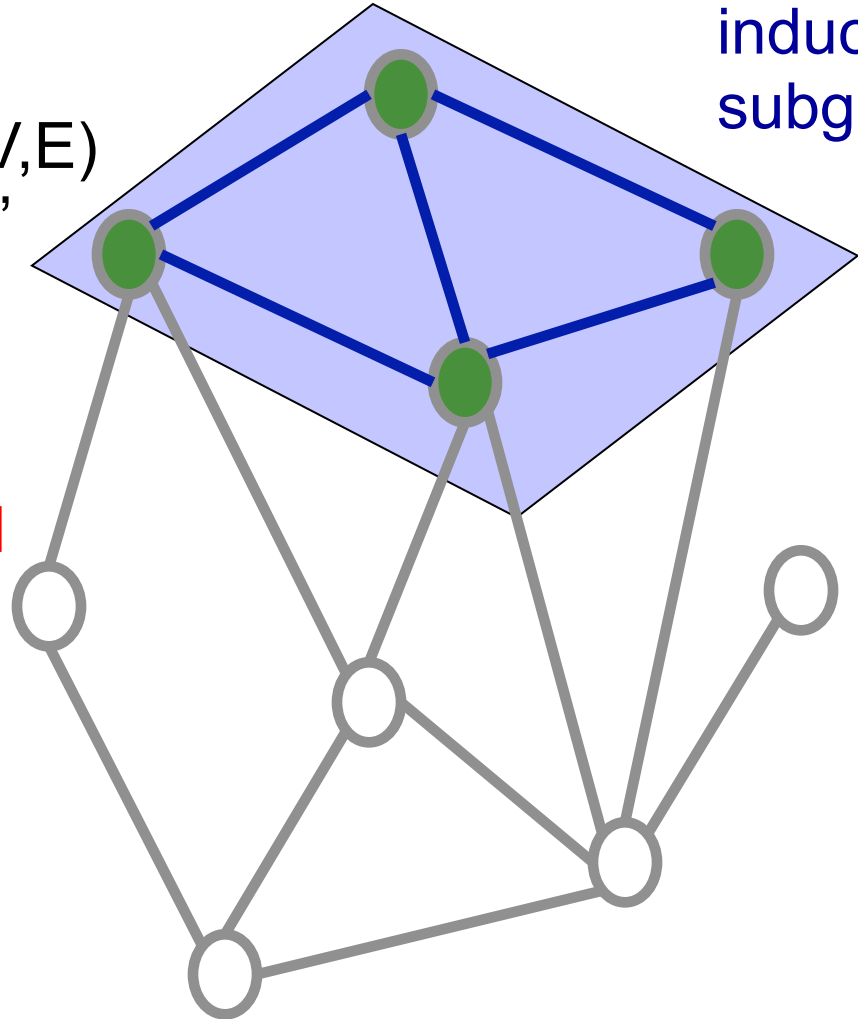

Question

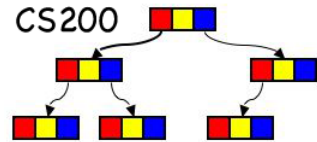

- A Tree is a subtype (special type) of Graph.
 - A. True
 - B. False

Paths

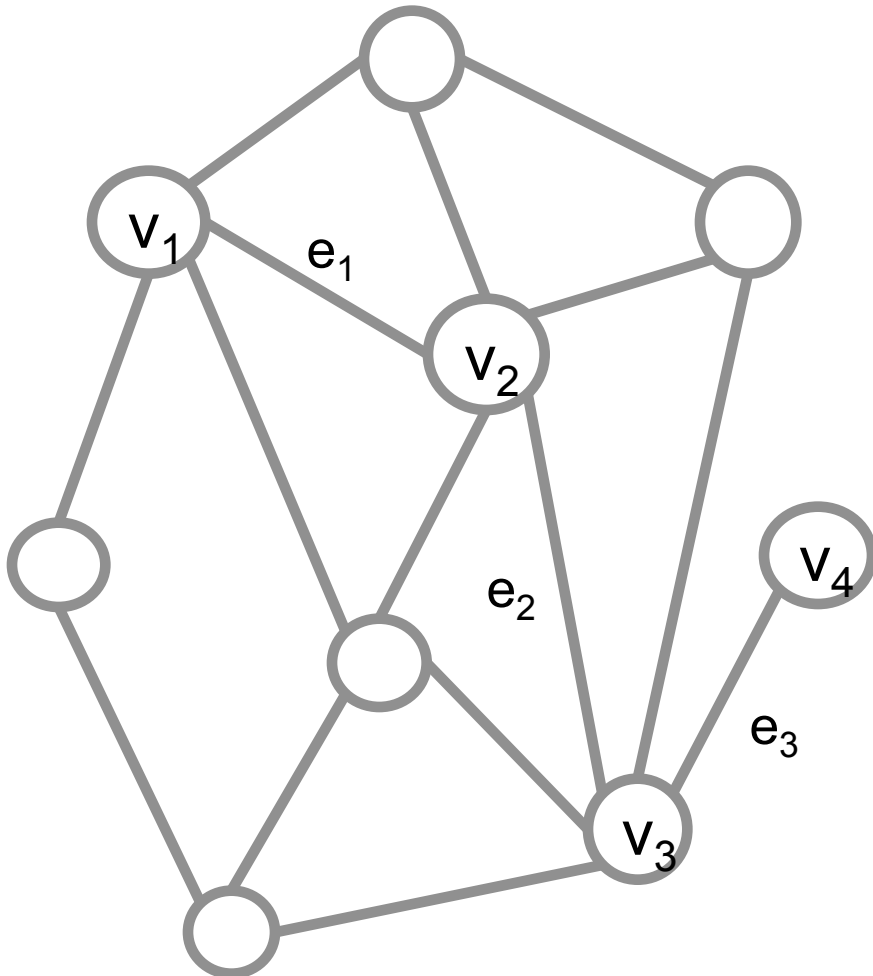
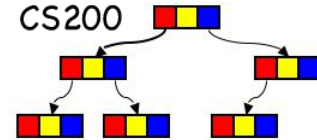

- **Path:** a sequence of edges, e.g. $((v_1, v_2), (v_2, v_3), (v_3, v_4))$ s.t. the first node in the next edge is the second node in the previous edge.
- A simple path passes **through** a vertex only once.
- (e_1, e_2, e_3) is a simple path of length 3 from v_1 to v_4
- A path can be represented by a sequence of vertices, here (v_1, v_2, v_3, v_4)

Graph Terminology

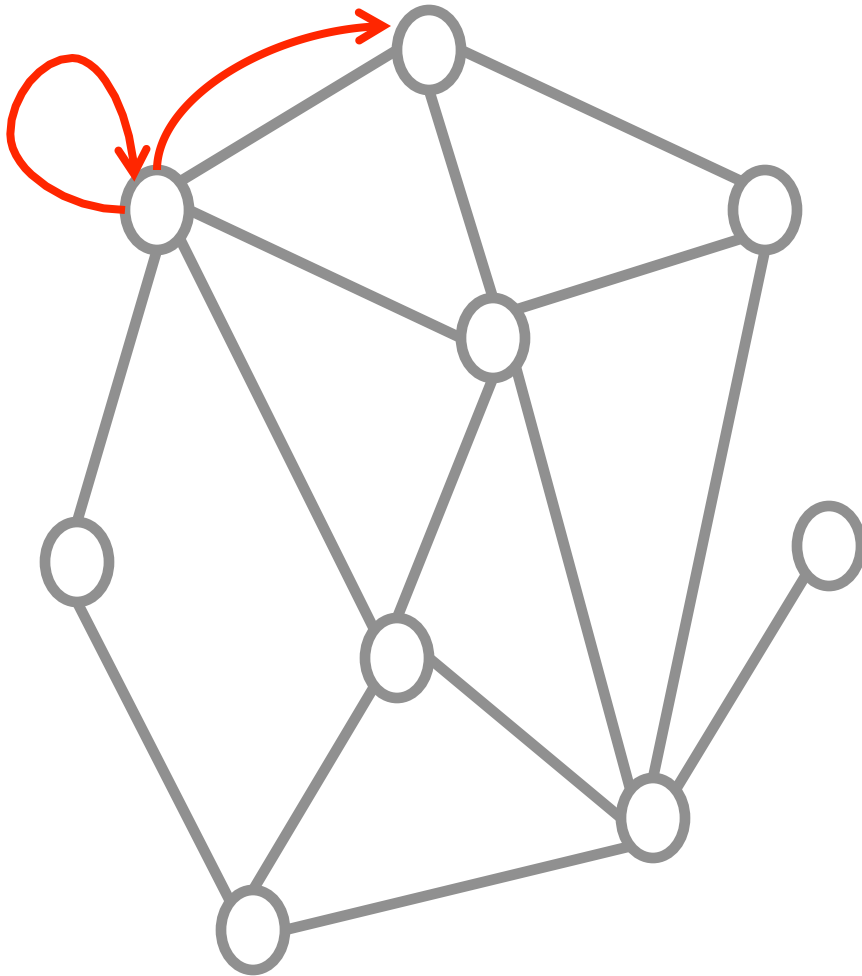
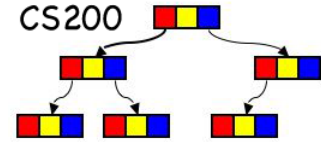

Self loop (loop): an edge that connects a vertex to itself

(Simple) Graph: no self loops and no two edges connect the same vertices (E is a set, so no multiples). We are mostly thinking about these.

Multigraph: may have multiple edges connecting the same vertices (not a graph: E is a set in graph)

Pseudograph: multigraph with self-loops

Complete Graphs



- Simple graph that contains exactly one edge between each pair of distinct vertices.

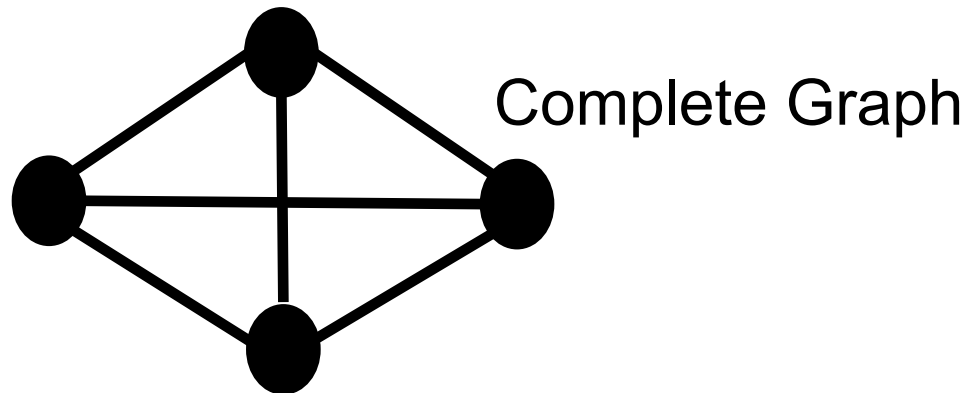

Question

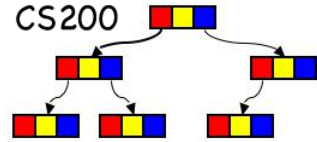

Which describes this graph?

- A. Simple
- B. Pseudograph
- C. Cycle
- D. Complete

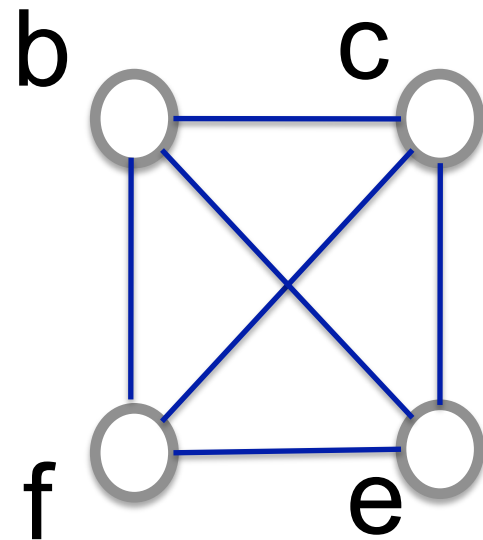

Question

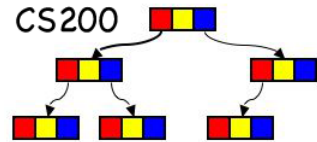

Which describes this graph?

- A. Simple
- B. Pseudograph
- C. Cycle
- D. Complete

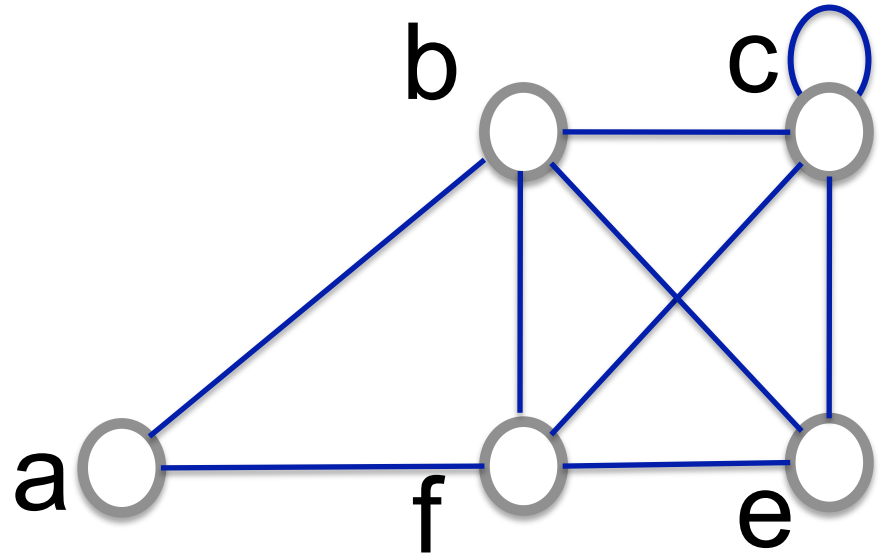

Cycles

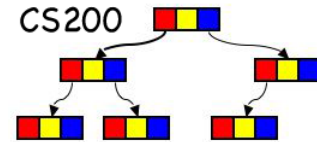

The cycle C_n , $n \geq 3$, consists of n vertices

v_1, v_2, \dots, v_n and n edges

$\{v_1, v_2\}, \{v_2, v_3\}, \dots, \{v_{n-1}, v_n\}, \{v_n, v_1\}$.

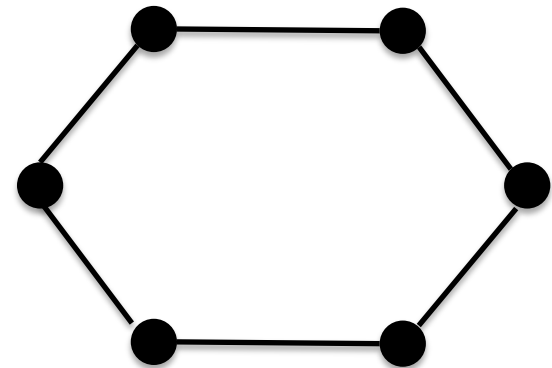
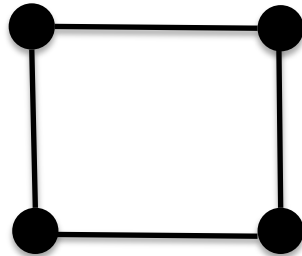
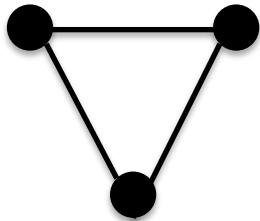

Wheels

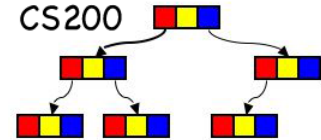

- We obtain the wheel W_n when we add an additional vertex to the cycle C_n , and connect this new vertex to each of the n vertices in C_n , by new edges

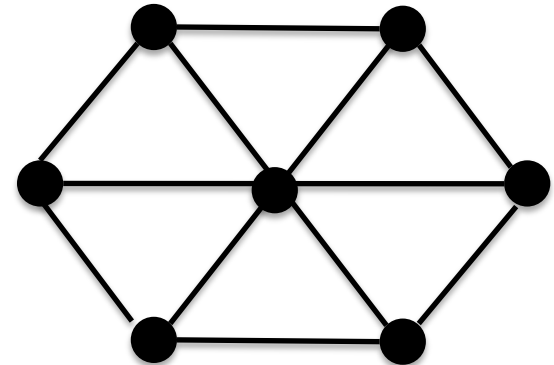
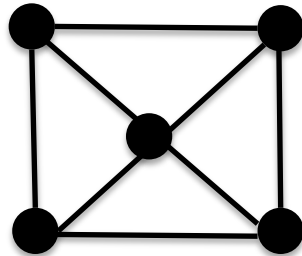
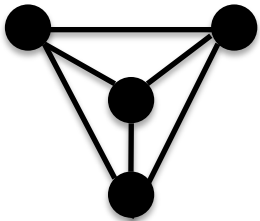

n -Cube (n -dimensional hypercube)

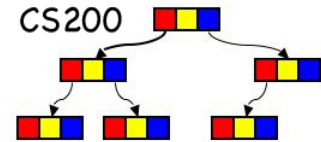

Hypercube

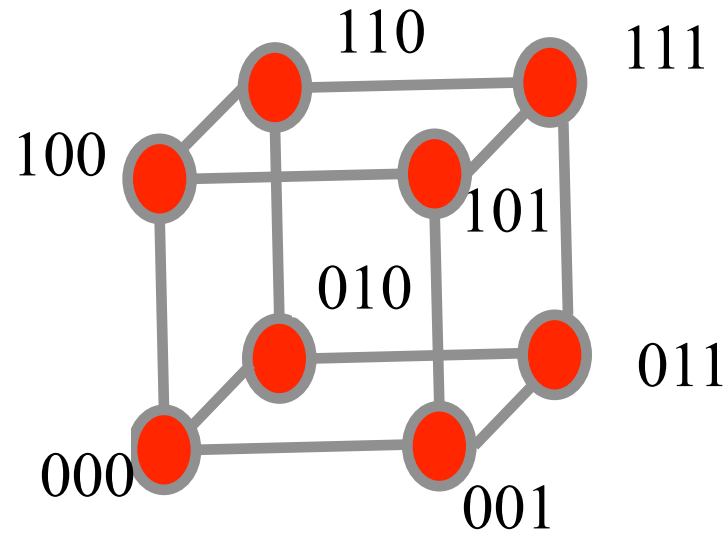

The degree of a vertex

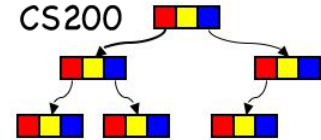

- The degree of a vertex in an undirected graph
 - the number of edges incident with it
 - except that a loop at a vertex contributes twice to the degree of that vertex.

Example

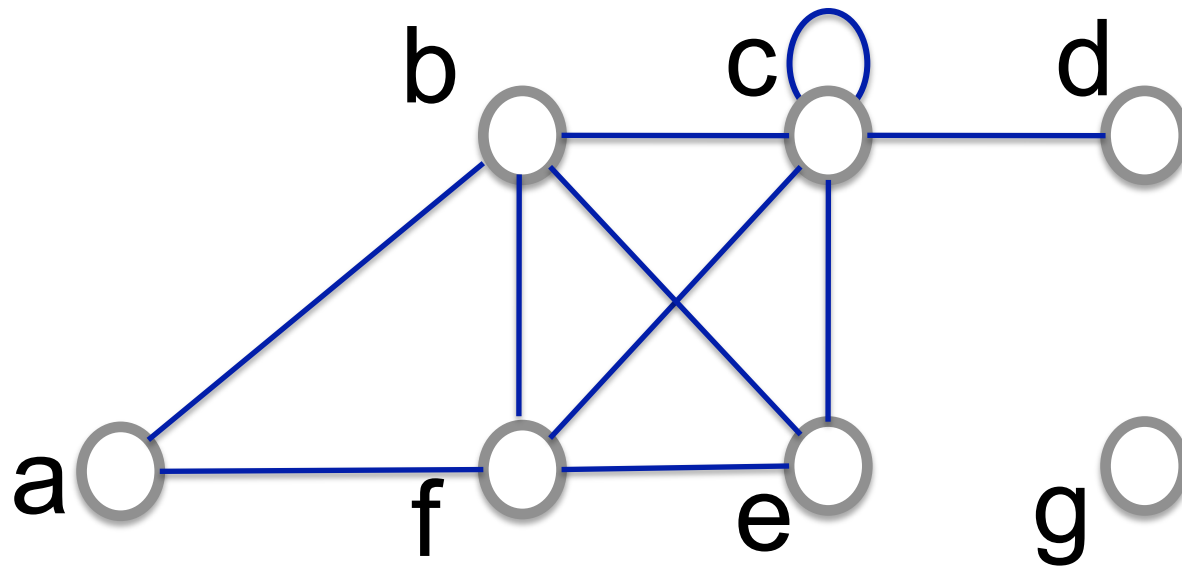
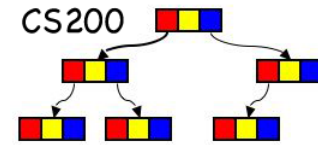

d is “pendant”

g is “isolated”

$$\begin{aligned} \text{deg}(a) &= 2 \\ \text{deg}(b) &= \text{deg}(f) = 4 \end{aligned}$$

$$\begin{aligned} \text{deg}(d) &= 1 \\ \text{deg}(e) &= 3 \\ \text{deg}(g) &= 0 \end{aligned}$$

Question



What is the degree of c ?

- A. 4
- B. 5
- C. 6

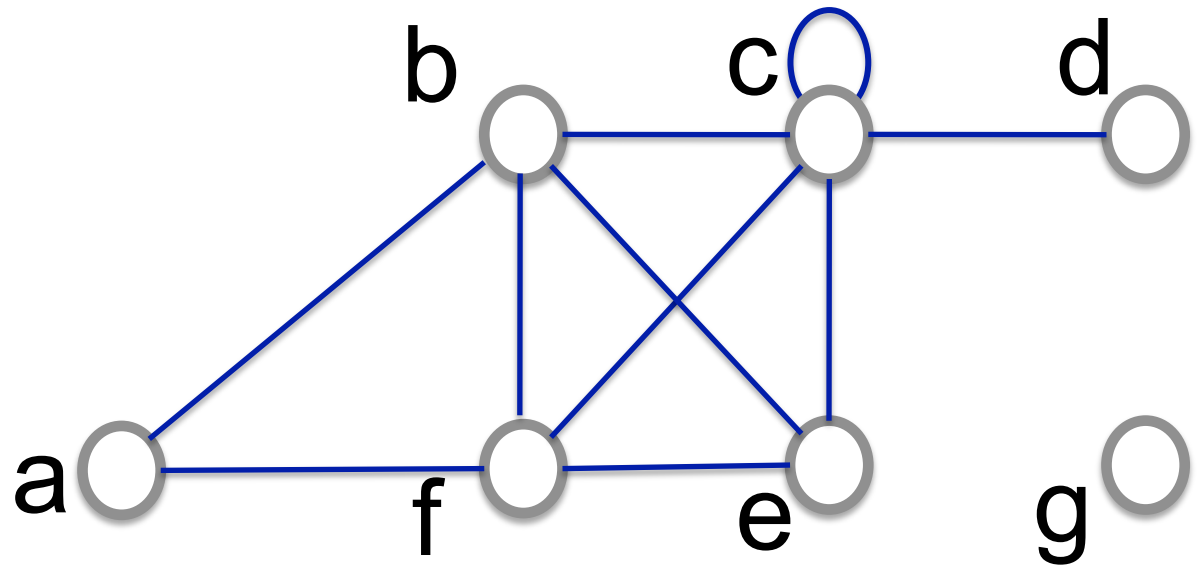

Directed Graphs

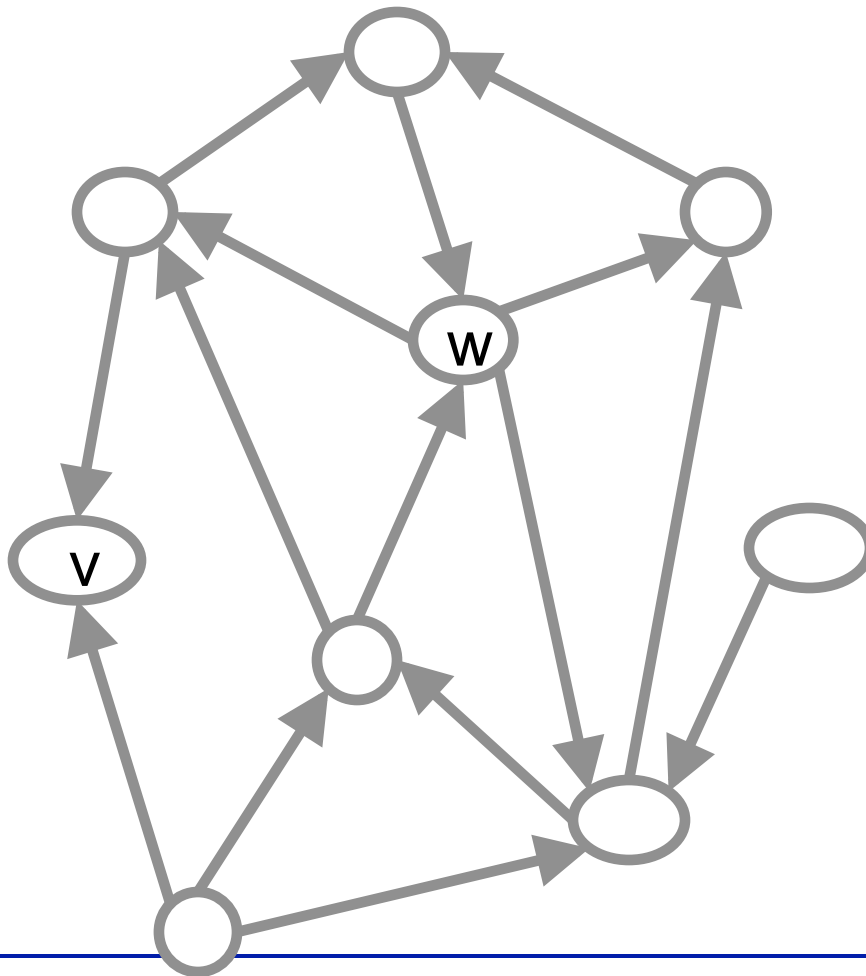

Indegree: number of incoming edges
Outdegree: number of outgoing edges

Some Graph Theorems

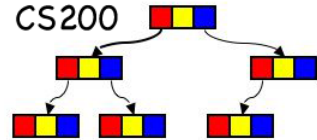

- *Handshaking*: Let $G=(V,E)$ be an undirected graph with m edges. Then

$$2m = \sum_{v \in V} \deg(v)$$

- An undirected graph has an even number of vertices of odd degree.
- Let $G=(V,E)$ be a directed graph. Then

$$\sum_{v \in V} \deg^-(v) = \sum_{v \in V} \deg^+(v) = |E|$$

Bipartite Graphs

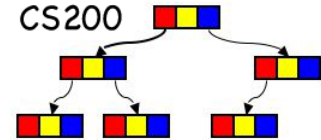

- A simple graph on which the vertex set V can be partitioned into two disjoint sets V_1 and V_2 such that every edge connects a vertex in V_1 to one in V_2 .
- Bipartite?

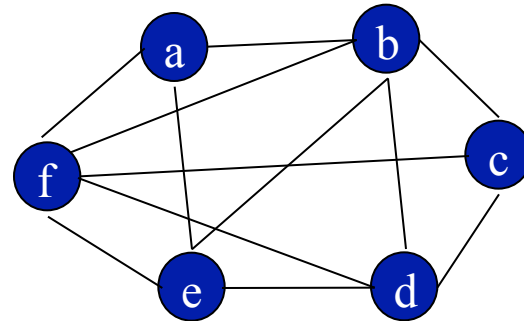
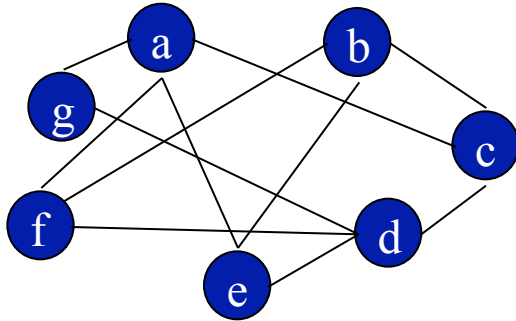

- **Theorem:** A simple graph is bipartite iff it is possible to assign one of two different colors to each vertex of the graph so that no two adjacent vertices are assigned the same color.

Bipartite Graphs

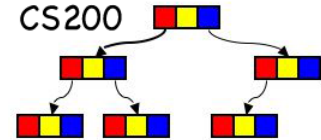

- Assign colors

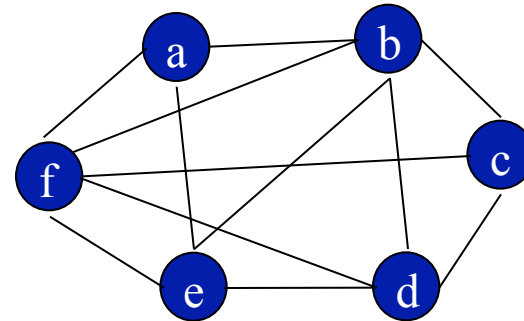
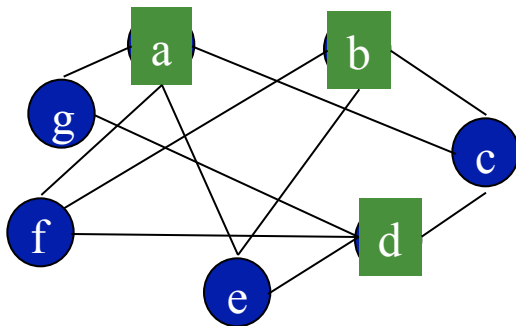

Theorem:
A graph G is bipartite iff
it contains no odd cycle

Question

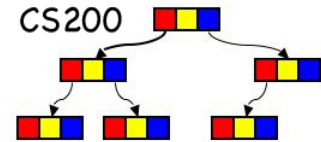

■ Is this graph bipartite?

A. Yes

B. No

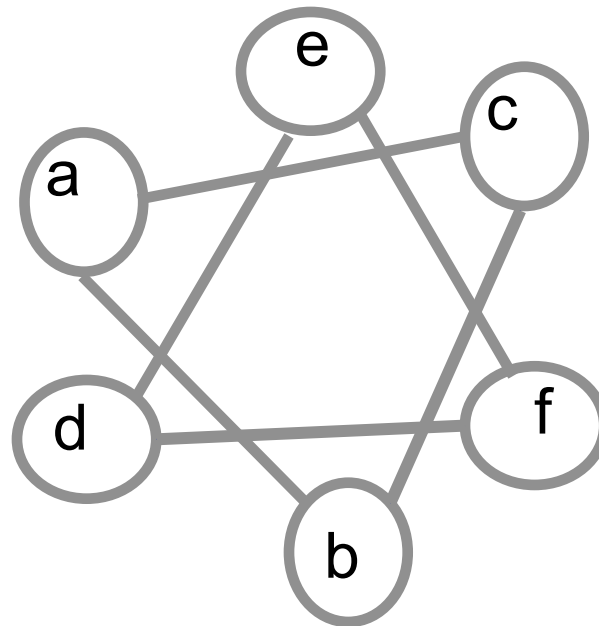

Connected Components

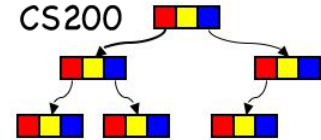

- An undirected graph is called **connected** if there is a path between every pair of vertices of the graph.
- A **connected component** of a graph G is a connected subgraph of G that is not a proper subgraph of another connected subgraph of G .

$$G = \{\{a, b, c, d, e, f, g\}, E\}$$

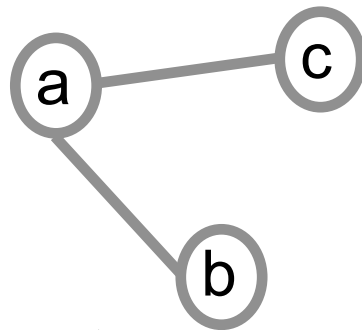

$$G_1 = \{\{a, b, c\}, E_1\}$$

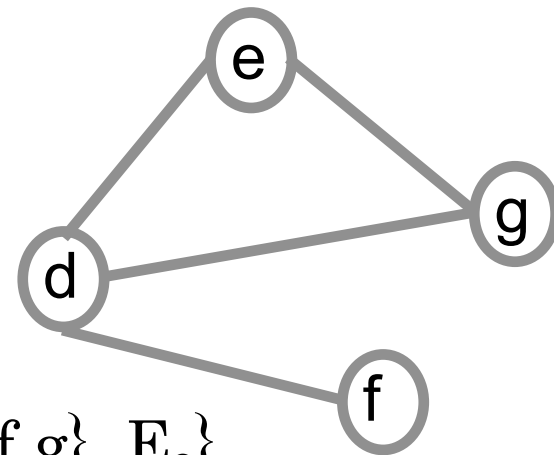

$$G_2 = \{\{d, e, f, g\}, E_2\}$$

Question



■ How many connected components does it have?

- A. 0
- B. 1
- C. 2

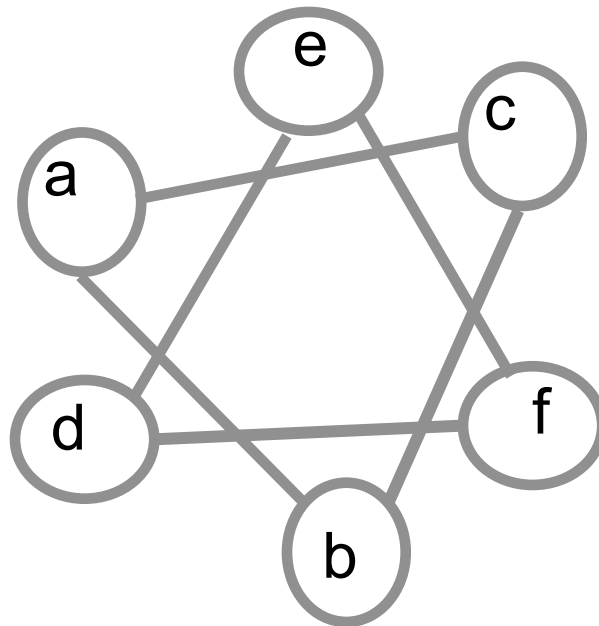

Connectedness in Directed Graphs

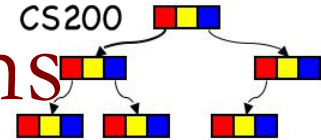

- A directed graph is ***strongly connected*** if there is a path from a to b and from b to a for all vertices a and b in the graph.
- A **directed** graph is ***weakly connected*** if there is a path between every two vertices in the underlying **undirected** graph.

A/B strongly/weakly connected?

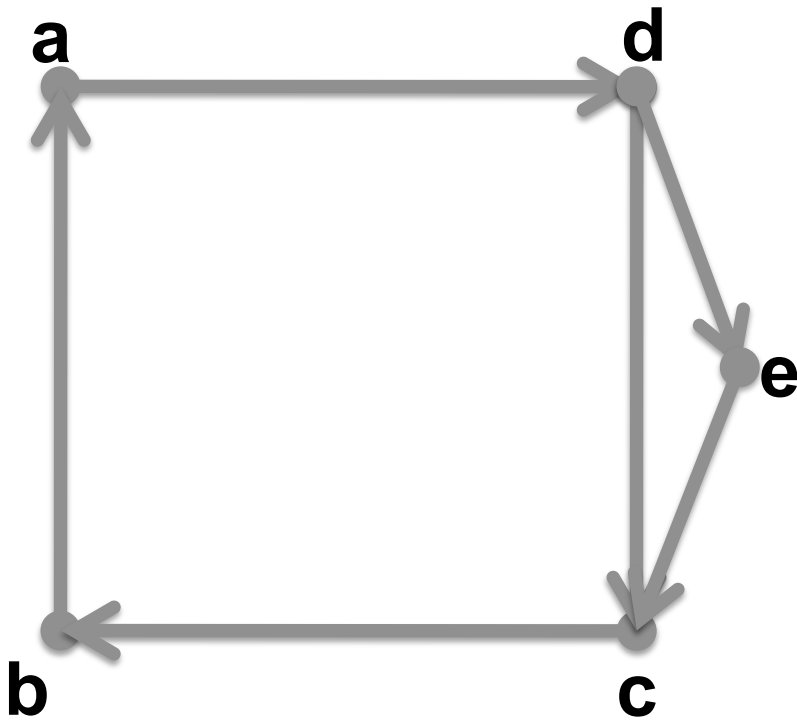
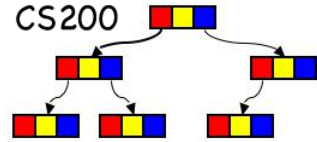

Graph A

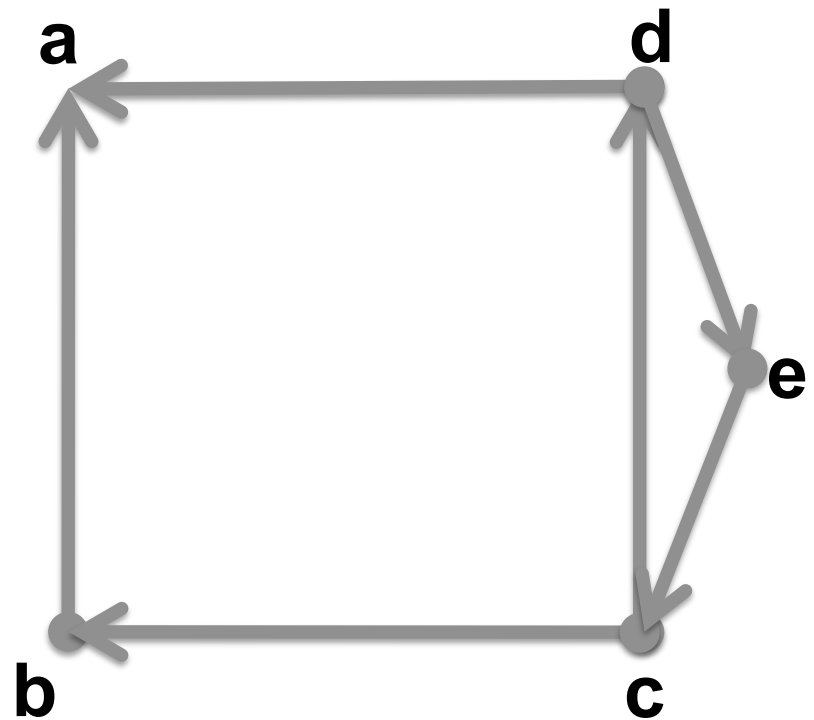

Graph B

Graph Data Structures - Adjacency Matrix

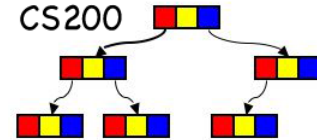

- Vertices
 - row and column indices mapped to labels
 - one vertex mapped to **one** index
- Edges
 - entries in a square matrix
 - size = (number of vertices)²
 - edge: two (vertex) indices
 - values:
 - boolean to indicate presence/absence of edge in (un)directed graph
 - int to indicate value of weighted edge (0: no edge)
- useful for dense graphs

Adjacency Matrix Example

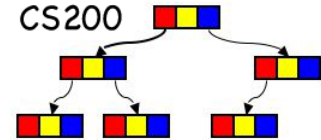

For undirected graph,
what would adjacency
matrix look like?

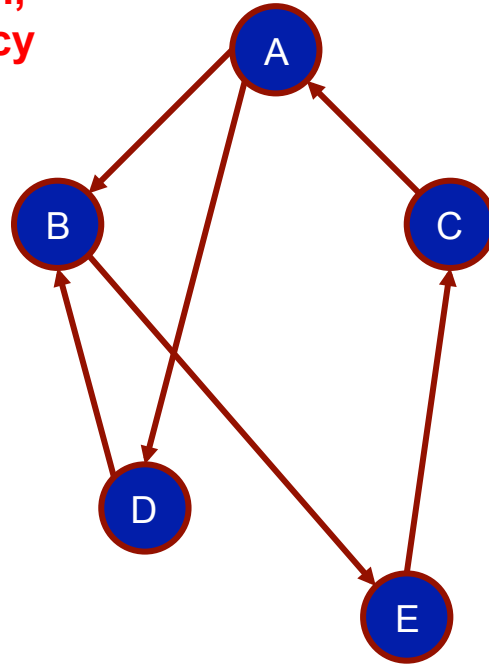

Label	Index
A	0
B	1
C	2
D	3
E	4

mapping of vertex
labels to array indices

In a weighted
graph, cells would
contain weights

	0	1	2	3	4
0	0	1	0	1	0
1	0	0	0	0	1
2	1	0	0	0	0
3	0	1	0	0	0
4	0	0	1	0	0

Adjacency Matrix:
array of edges indexed
by vertex number

Question

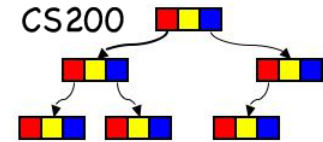

Is this an undirected graph?

- A. Yes
- B. No

	0	1	2	3	4
0	0	1	1	0	0
1	1	0	0	1	1
2	1	0	0	0	1
3	0	1	0	1	0
4	0	1	1	0	0

Adjacency Matrix:

Question

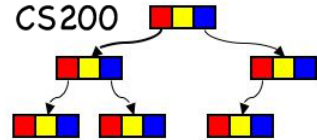

Is this a simple graph?

- A. Yes
- B. No

	0	1	2	3	4
0	0	1	1	0	0
1	1	0	0	1	1
2	1	0	0	0	1
3	0	1	0	1	0
4	0	1	1	0	0

Adjacency Matrix:

Graph Data Structures - Adjacency List

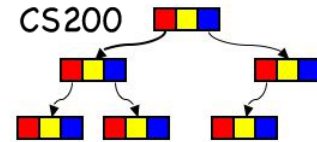

- Vertices
 - mapped to list of adjacencies
 - adjacency: edge
- Edges: lists of adjacencies
 - linked-list of out-going edges per vertex
- useful for sparse graphs

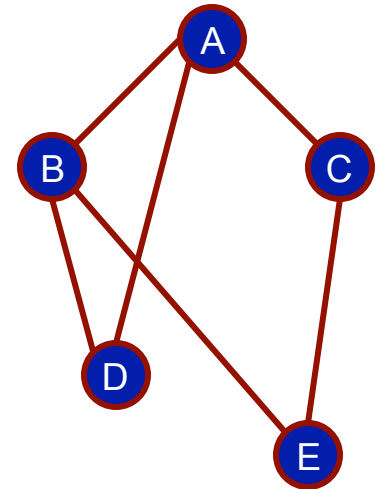

Adjacency List: Undirected Graph

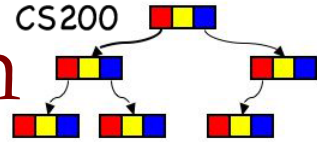

ArrayList

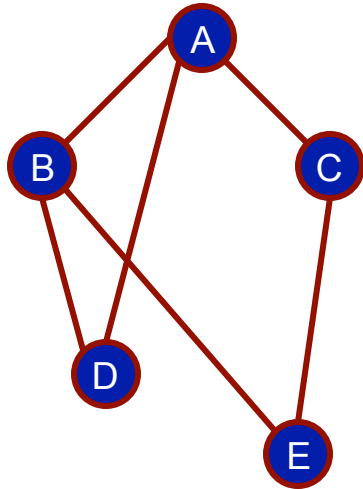

Index	Label	ArrayLists
0	A	B C D
1	B	A D E
2	C	A E
3	D	A B
4	E	B C

mapping of vertex
labels to list of edges

Adjacency List: Directed Graph

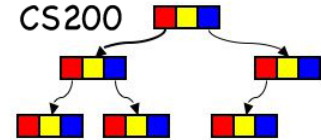

ArrayList

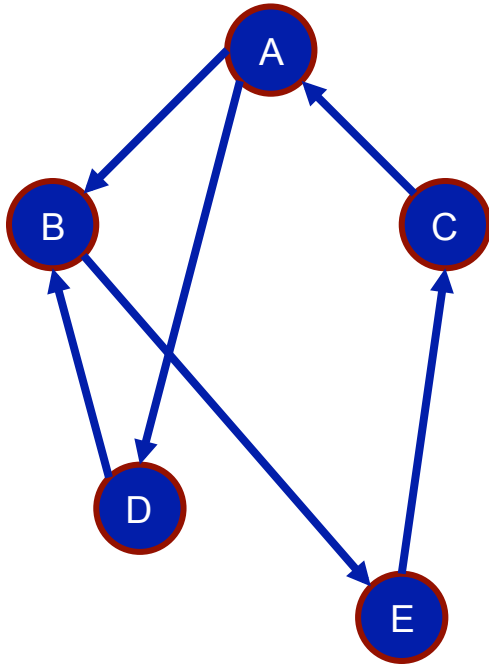

Index	Label	ArrayLists
0	A	B D
1	B	E
2	C	A
3	D	B
4	E	C

This representation is used in Graph recitation and assignment

Which Implementation Is Best?

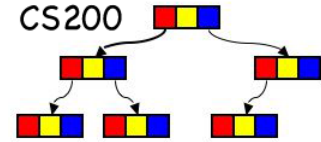

- Which implementation best supports common Graph Operations:
 - Is there an edge between vertex i and vertex j ?
 - Find all vertices adjacent to vertex j
- Which best uses space?

Six Degrees of Kevin Bacon

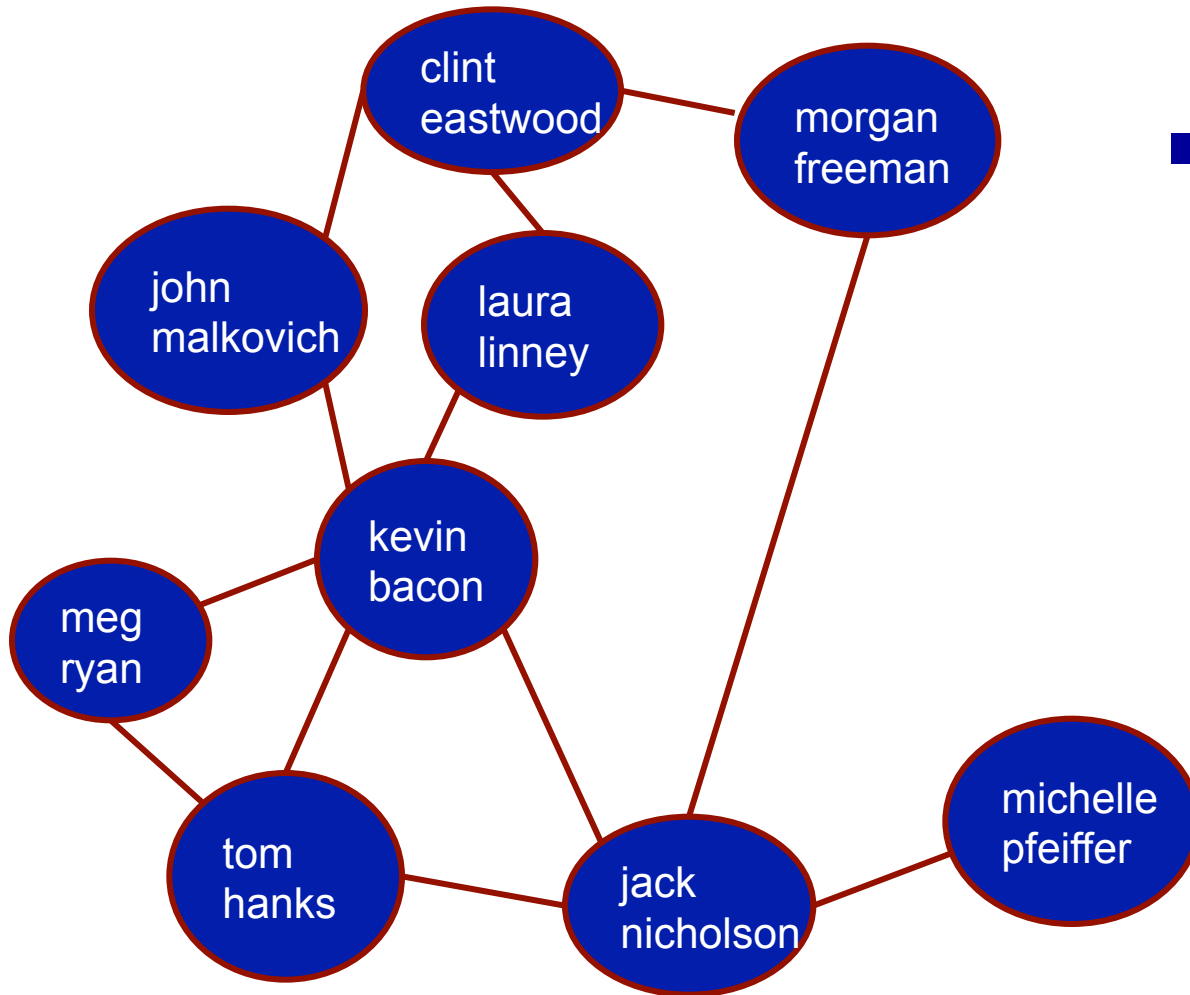
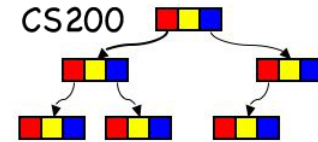

- Actor x has a Kevin Bacon Number of n if **the shortest path** between x and Kevin Bacon has length n

Graph made with the help of the oracle of Bacon: <http://oracleofbacon.org/>

Shortest Path Algorithms

(Dijkstra's Algorithm)

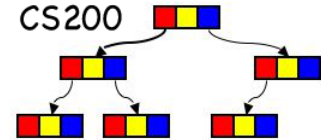

- Graph $G(V,E)$ with positive weights (“distances”)
- Compute shortest distances from source vertex s to ***every other vertex*** in the graph

Shortest Path Algorithms

(Dijkstra's Algorithm)

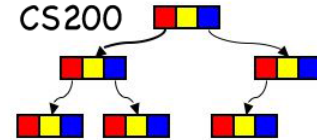

■ Algorithm

- Stepwise create a minimal path sub tree
 - initial: source
- Maintain array d (minimum distance estimates)
 - Init: $d[s]=0, d[v]=\infty, v \in V-s$
 - ∞ means: yet unreachable
- array of nodes **not yet visited** with shortest distance to already selected nodes
- select minimum path distance node v , update neighbors

Dijkstra's Algorithm

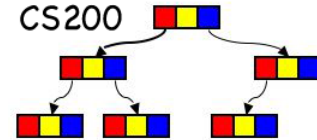

```
Dijkstra(G: graph with vertices  $v_0 \dots v_{n-1}$  and weights  $w[u][v]$ )  
// computes shortest distance of vertex 0 to every other vertex  
create an empty set, call it finalizedVertexSet  
d[0] = 0  
for (v = 1 through n-1)  
    d[v] = infinity  
for (step = 2 through n)  
    find the smallest d[v] such that v is not in  
finalizedVertexSet  
    add v to finalizedVertexSet  
    for (all vertices u not in finalizedVertexSet)  
        if (d[u] > d[v] + w[v][u])  
            d[u] = d[v] + w[v][u]
```

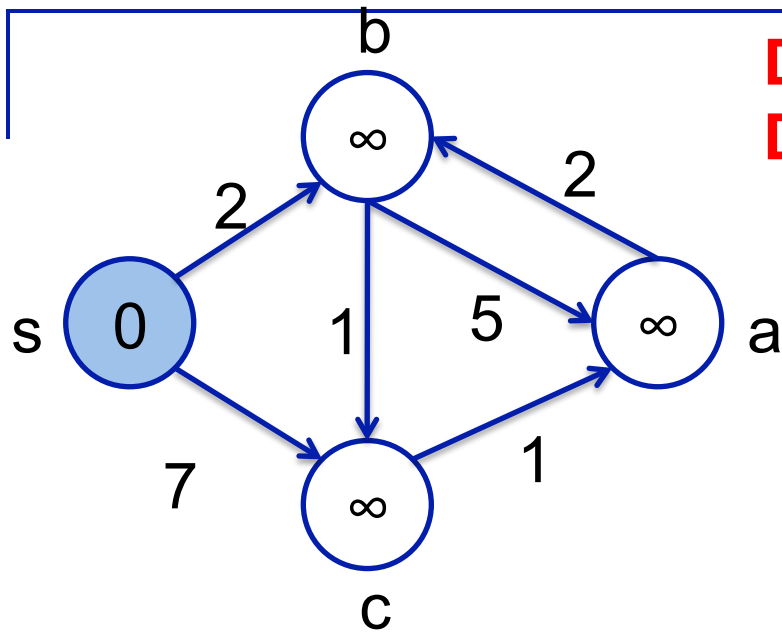

Do It
Do It

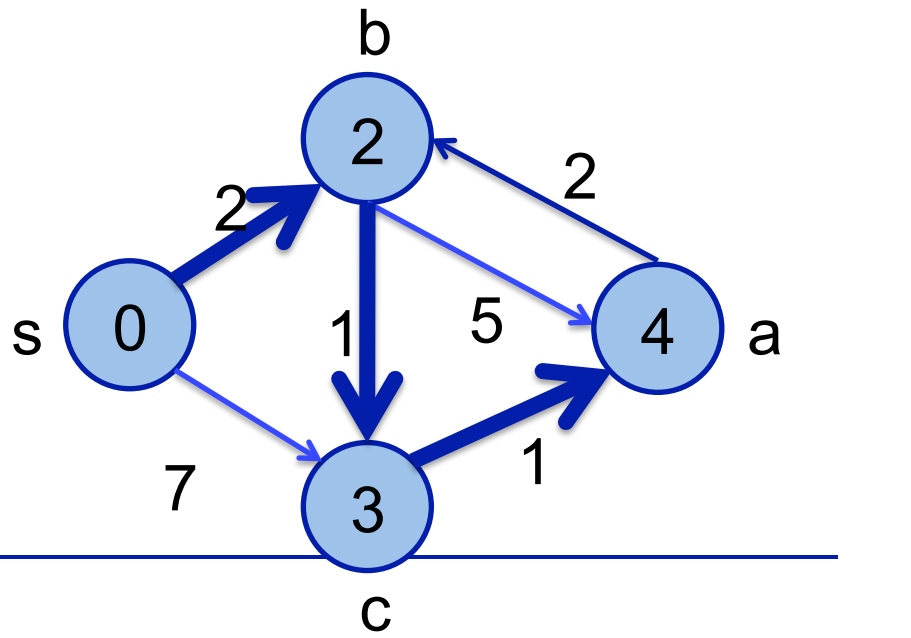
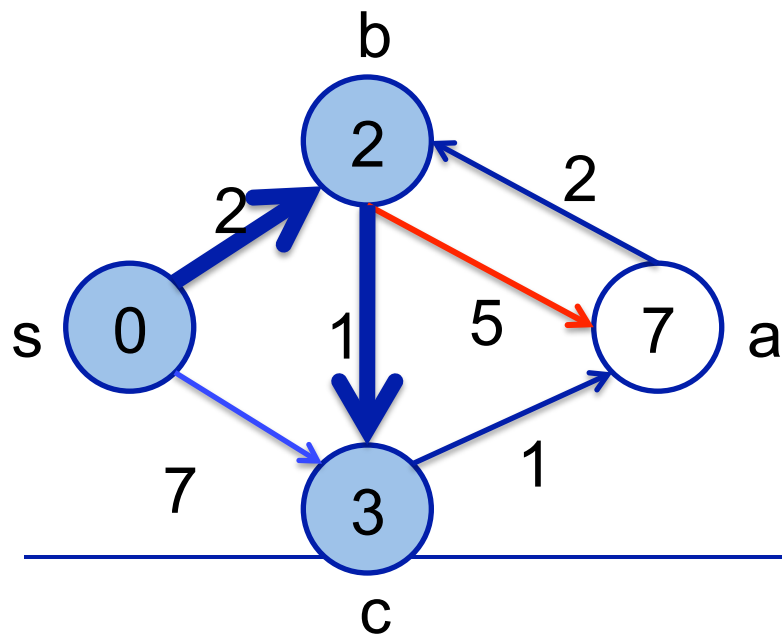
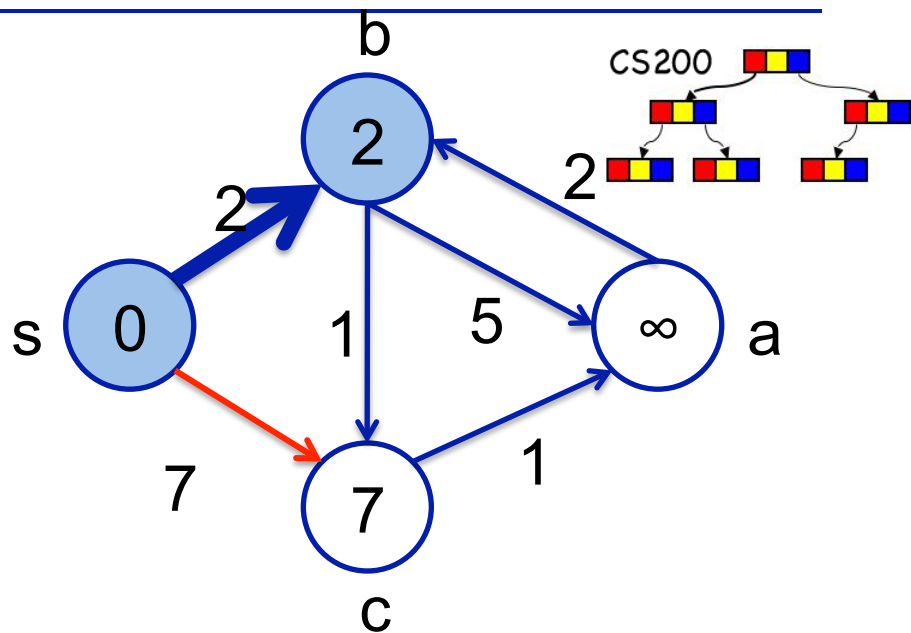

Recap: Priority Queue

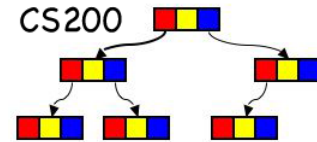

- A **Priority Queue** is a data structure that keeps a set of items (P, V) , consisting of a Priority P and a Value V , in sorted order of priority.
- Possible operations:
 - $\text{insert}(X(P_x, V_x))$
 - $\text{delete}(X(P_x, V_x))$

We have studied a clever data structure for priority queues: **heaps**

Shortest Path Algorithms

Using a Priority Queue (Dijkstra's Algorithm): step 1

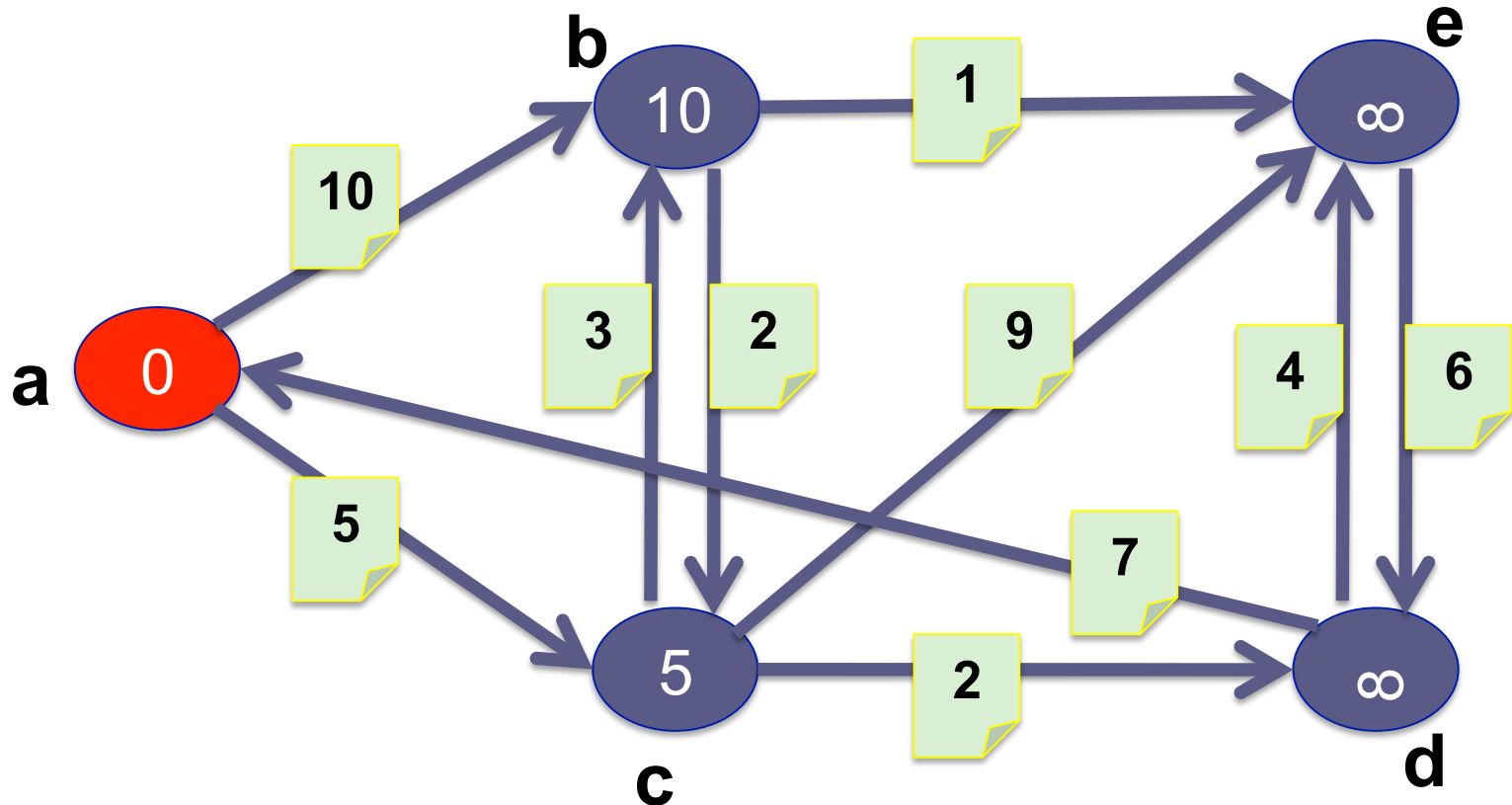
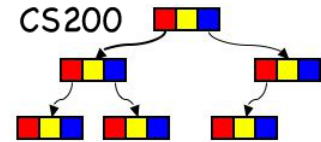

[5,c],[10,b]

Shortest Path Algorithms

(Dijkstra's Algorithm): step 2

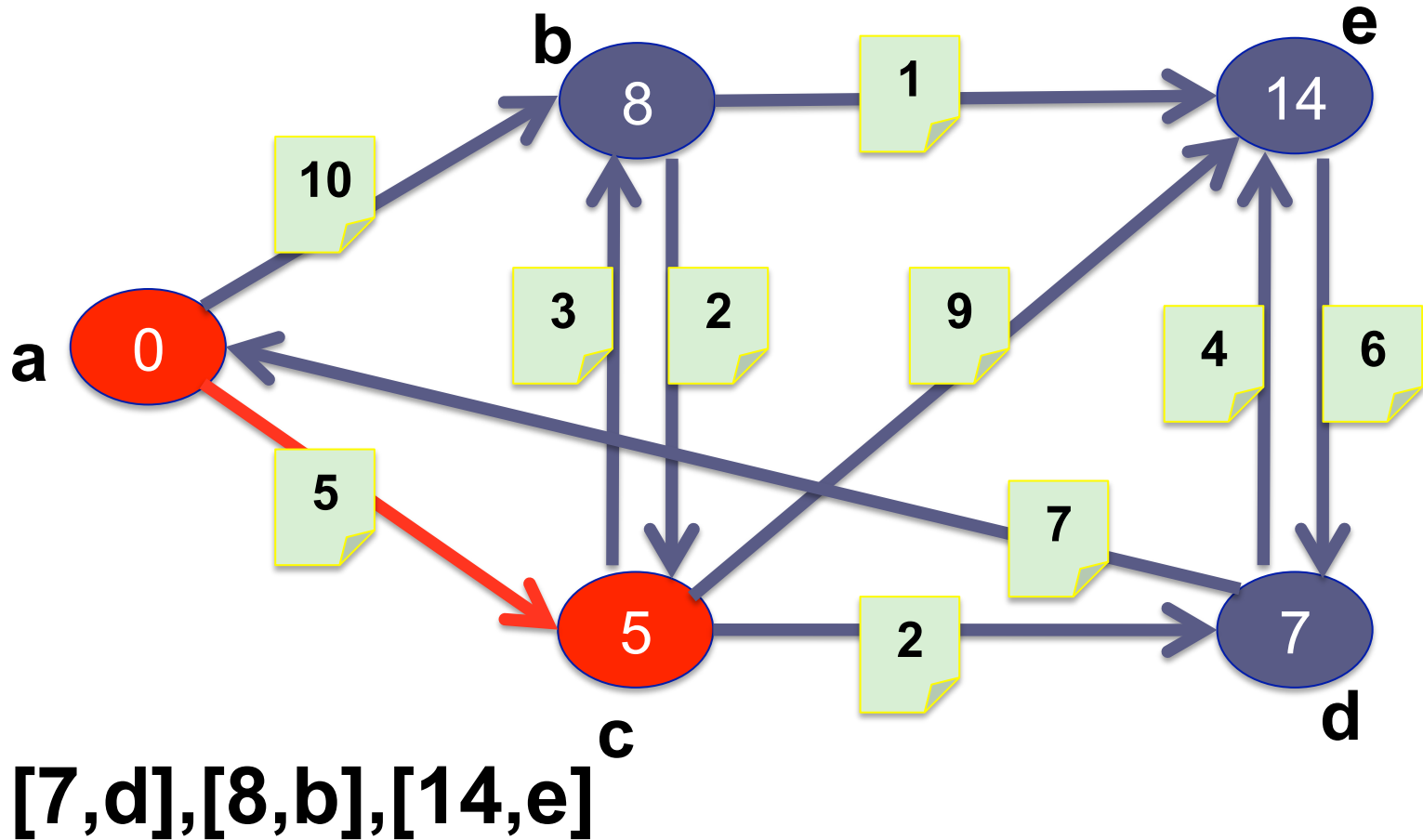
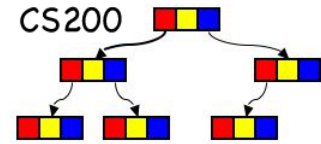

Shortest Path Algorithms

(Dijkstra's Algorithm): step 3

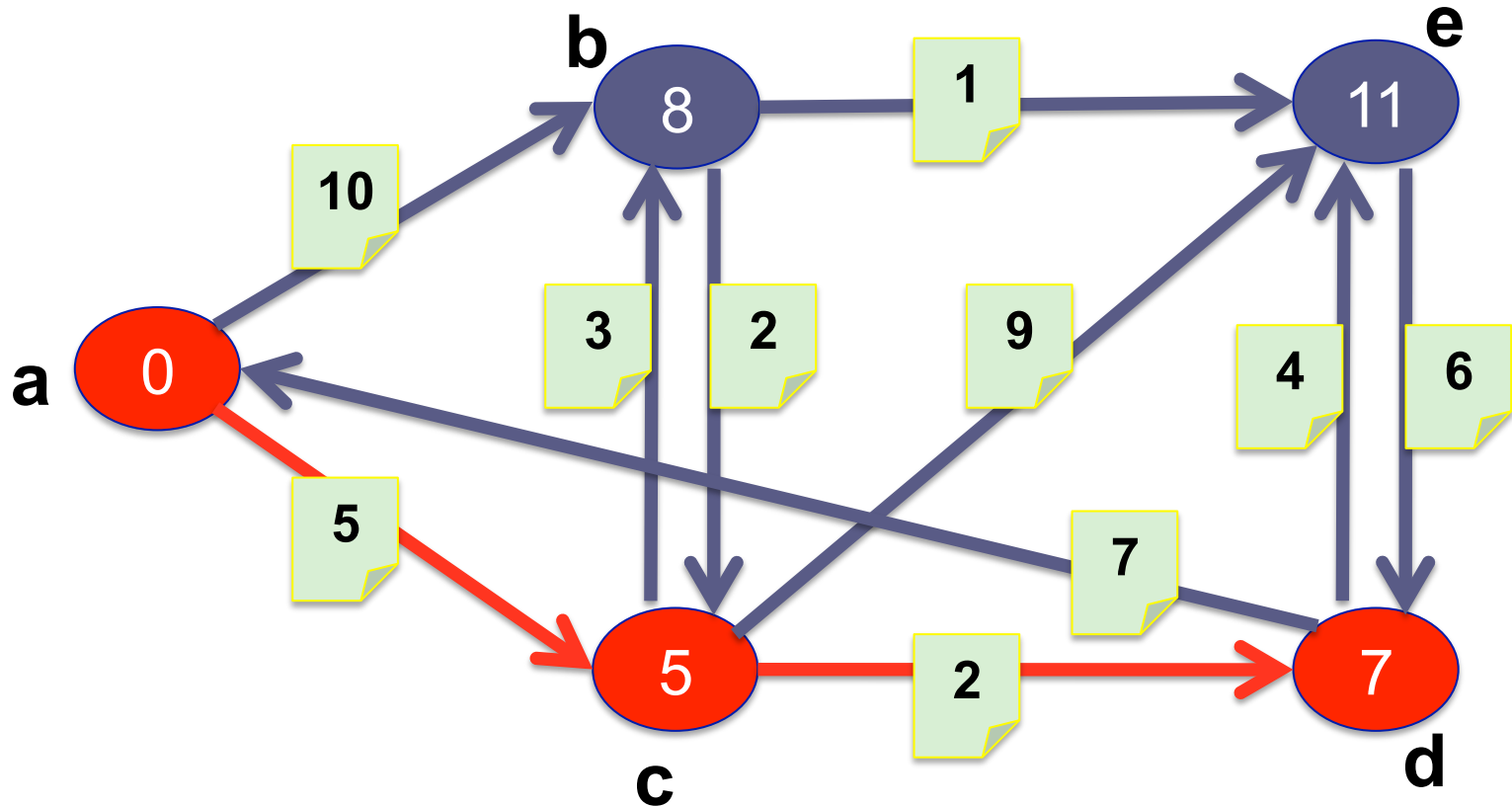
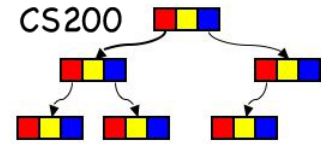

[8,b],[11,e]

Shortest Path Algorithms

(Dijkstra's Algorithm): step 4

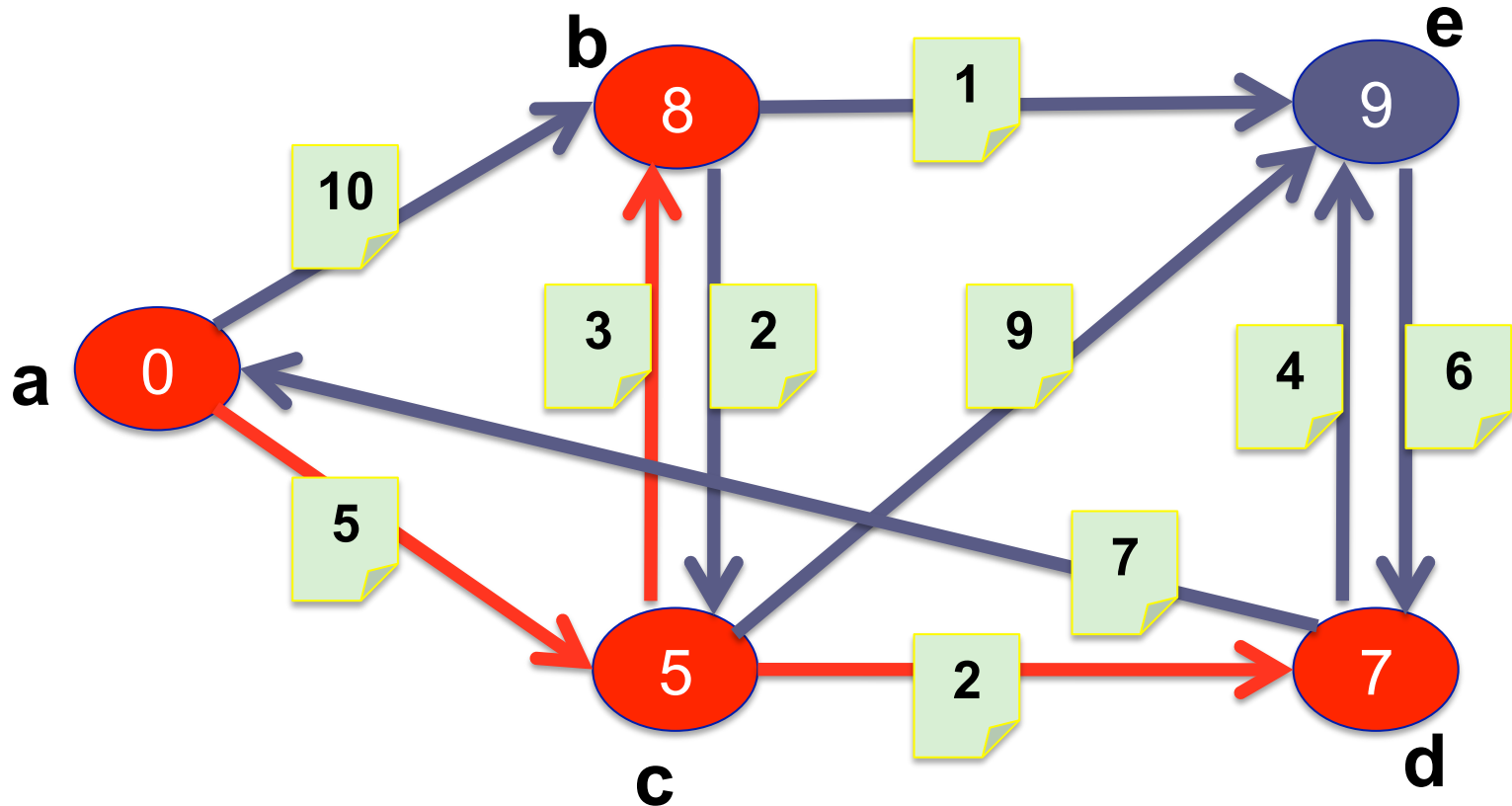
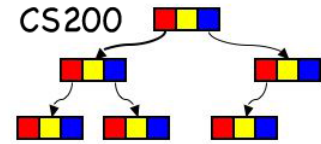

[9,e]

Shortest Path Algorithms

(Dijkstra's Algorithm): Done

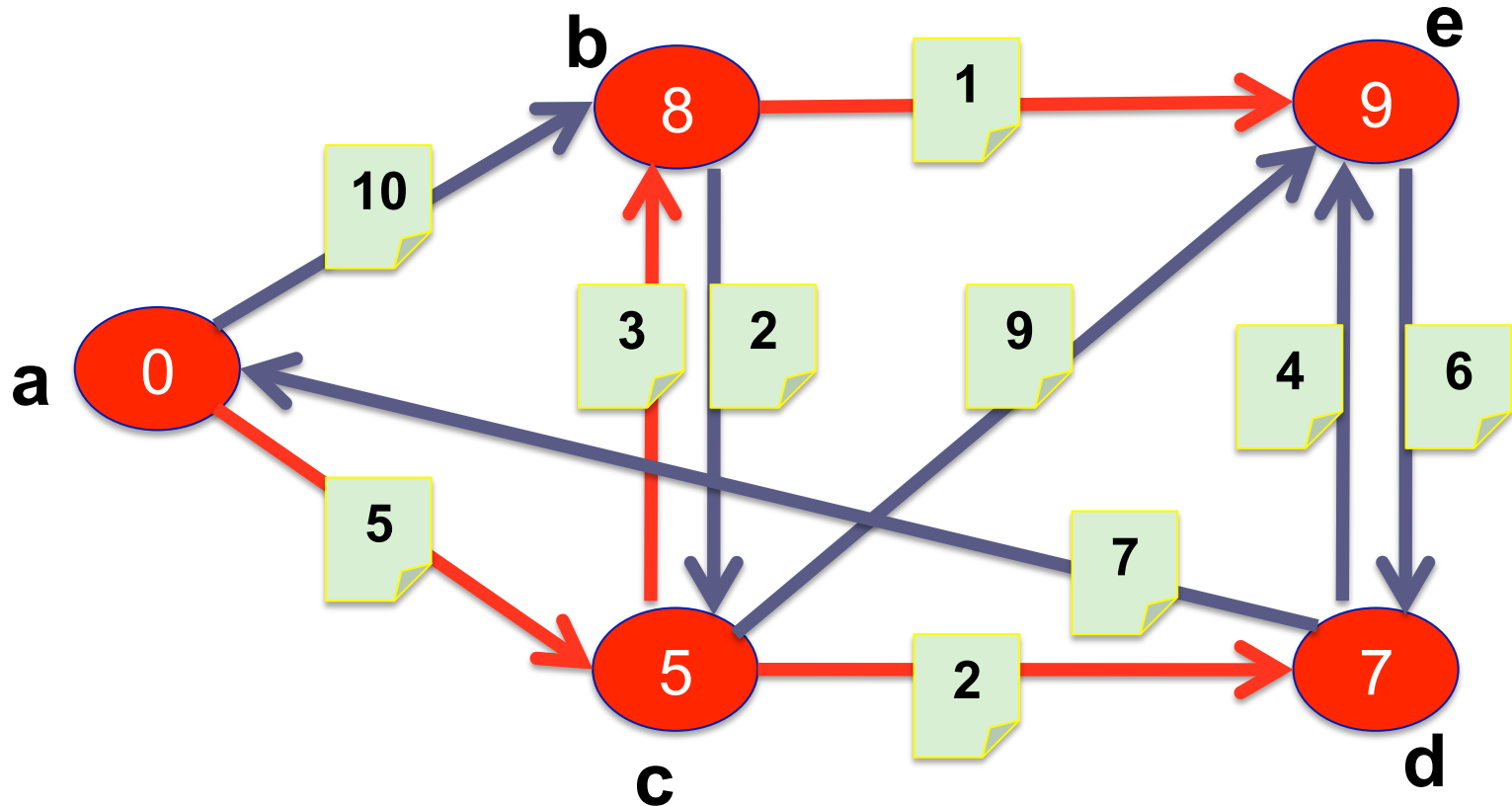
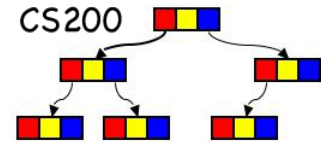

Dijkstra's Algorithm



- We have computed the shortest distances.
- How to obtain the shortest paths?
 - At each vertex maintain predecessor on path (parent in the minimal path tree)
 - From each node you can trace back to the source (the root of the minimal path tree)
 - Why maintain predecessor, why not successor?